

ITEM: CORNER GUARD

QTY: 1

CORNER GUARD

CORNER GUARDS	
X	# OF HOLES
1'-3'	3
4'-5'	4
6'-7'	5
8'-9'	6
10'	7

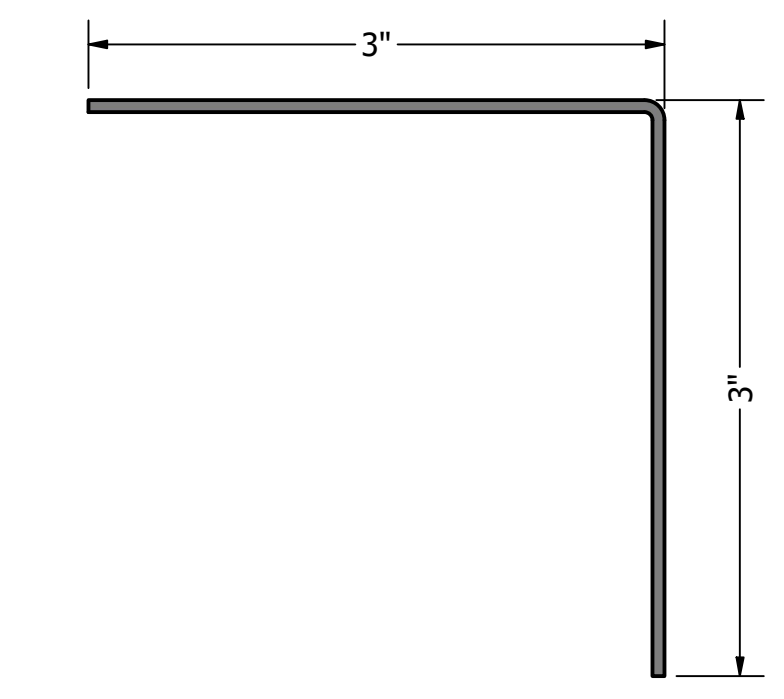
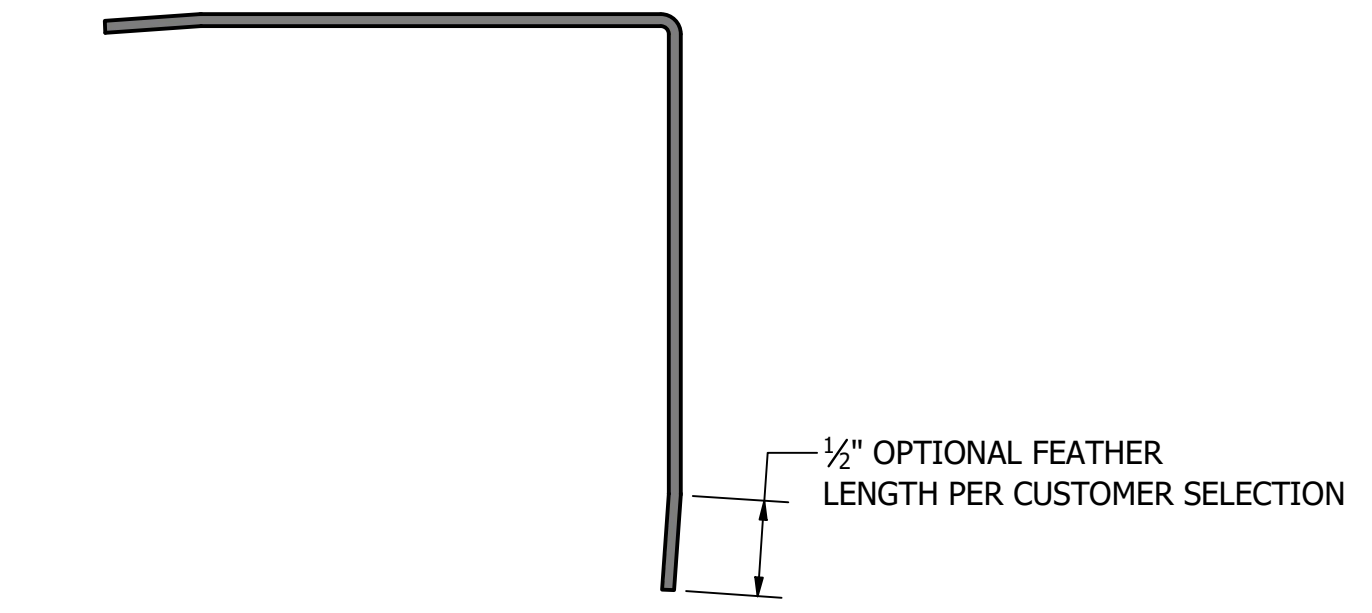

90 DEGREE CORNER GUARD
SCALE 1 : 1

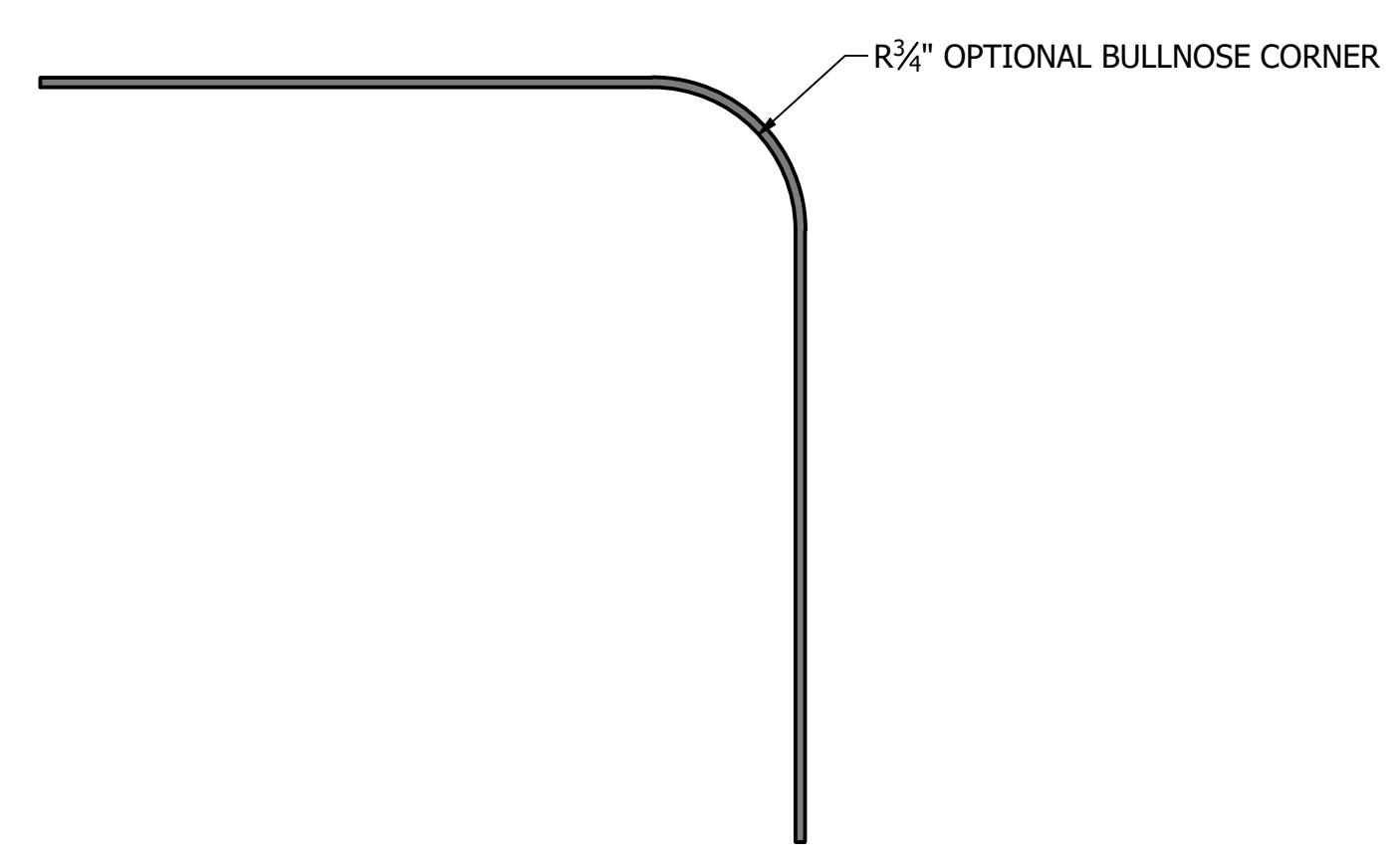

BULLNOSE CORNER GUARD
SCALE 1:1

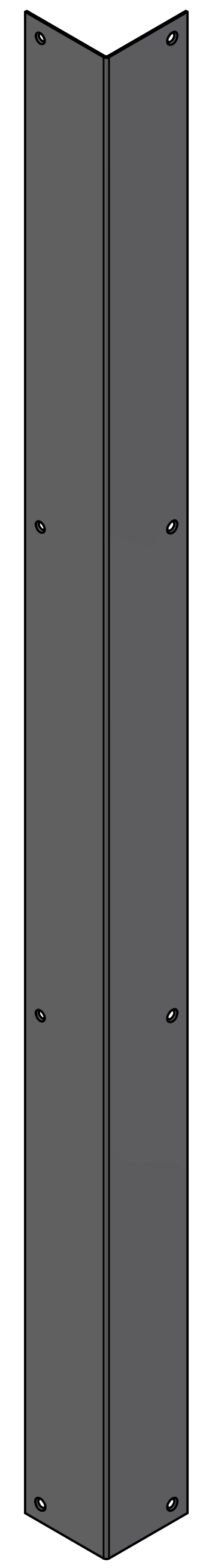

48" CORNER GUARD
SCALE 1:3

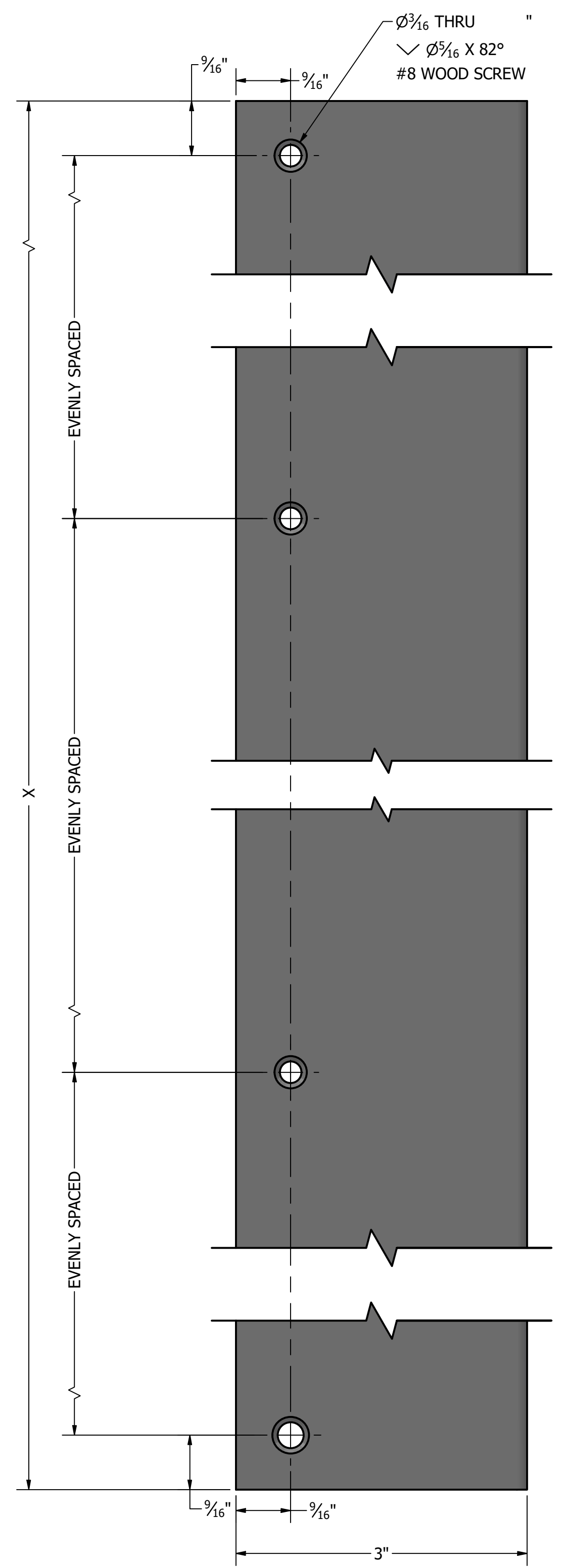

THESE PLANS AND THE DESIGNS CONTAINED HEREIN ARE THE PROPERTY OF GREAT LAKES STAINLESS, INC., AND MAY NOT BE REPRODUCED OR USED BY ANYONE, EITHER ALL OR IN PART, WITHOUT FIRST SECURING OUR WRITTEN PERMISSION.

DRAWN JACOB		1305 STEPKE COURT TRAVERSE CITY, MI. 49685 (888) 547-5282
PROJECT MANAGER:		JOB NAME : CORNER GUARD
REVISIONS:	CUSTOMER :	ITEM#:
TOLERANCES UNLESS OTHERWISE STATED: .XXXX ±.0002 .XXX ±.005 .XX ±.010 FRACTIONAL ±1/8" ANGLES ±1/2°	SIZE D CORNER GUARDS	CORNER GUARD
	DATE: 9/3/2021	SHEET 1 OF 2

ITEM: CORNER GUARD

QTY: 1

CORNER GUARDS

CORNER GUARDS	
X	# OF HOLES
1'-3'	3
4'-5'	4
6'-7'	5
8'-9'	6
10'	7

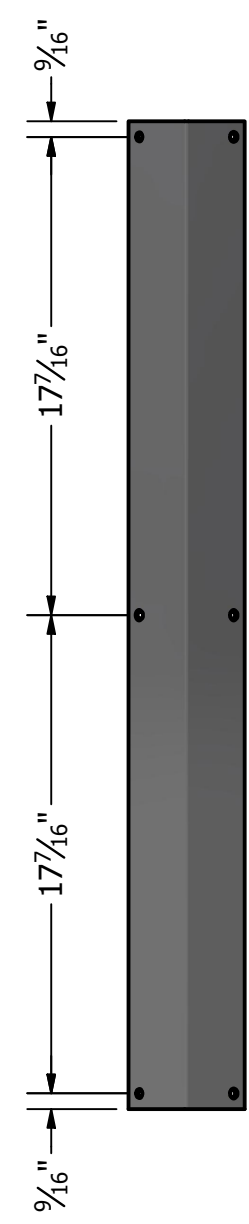

3'
SCALE 1:7

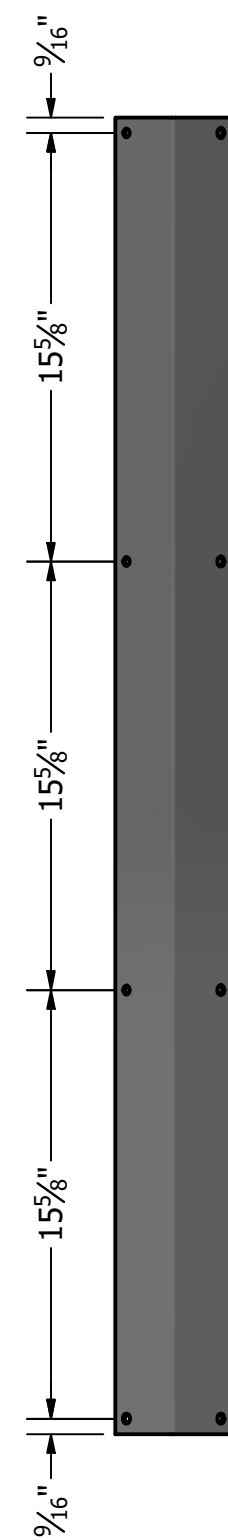

4'
SCALE 1:7

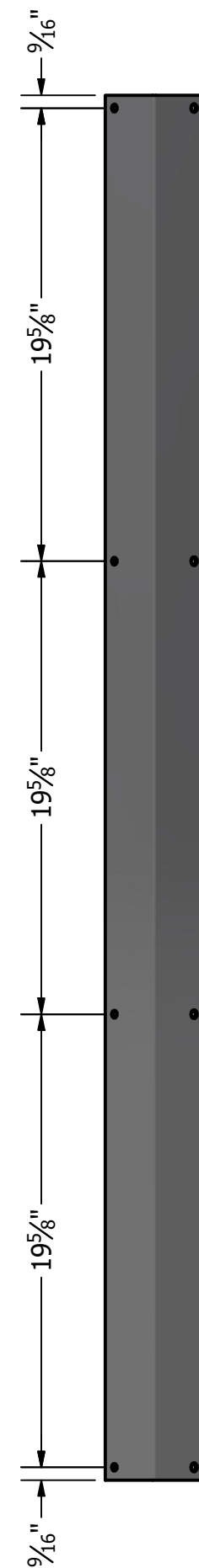

5'
SCALE 1:7

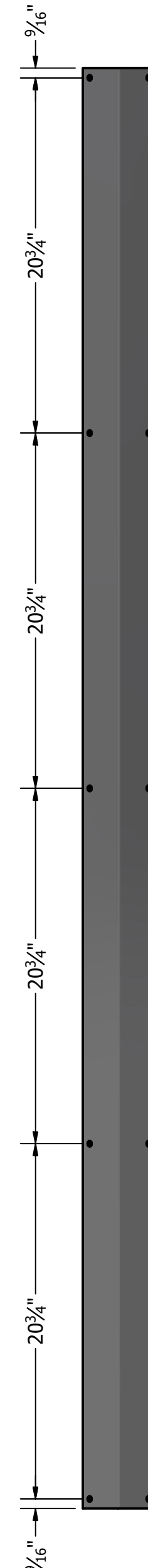

7'
SCALE 1:7

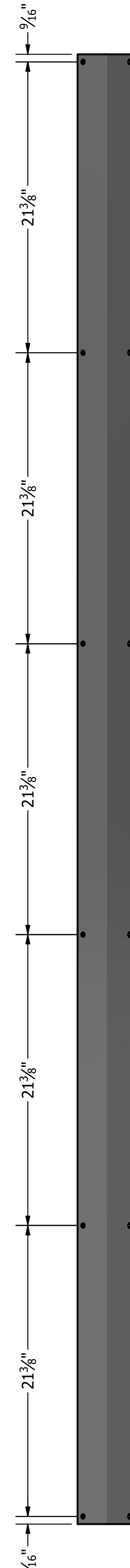

9'
SCALE 1:7

THESE PLANS AND THE DESIGNS CONTAINED HEREIN ARE THE PROPERTY OF GREAT LAKES STAINLESS, INC., AND MAY NOT BE REPRODUCED OR USED BY ANYONE, EITHER ALL OR IN PART, WITHOUT FIRST SECURING OUR WRITTEN PERMISSION.

DRAWN JACOB		1305 STEPKE COURT TRAVERSE CITY, MI. 49685 (888) 547-5282
PROJECT MANAGER:		JOB NAME : CORNER GUARD
REVISIONS:	CUSTOMER :	ITEM#:
TOLERANCES UNLESS OTHERWISE STATED: XXXX ±.0002 XXX ±.005 XX ±.010 FRACTIONAL ±1/8" ANGLES ±1/2°	SIZE DWG NO D CORNER GUARDS	CORNER GUARD
DATE: 9/3/2021	SHEET 2 OF 2	